

ALFA series

Model: ALFA 12K WIFI, ALFA 18K WIFI, ALFA 24K WIFI



SPLIT TYPE INVERTER AIR-CONDITIONER

ALFA series

Models: ALFA 12K WIFI, ALFA 18K WIFI, ALFA 24K WIFI

OWNER'S MANUAL





TABLE OF CONTENTS

1.Refrigerants R32 & R290.....	3
1.1.Introduction.....	3
1.2.Room area requests for ait conditioner with refrigerants.....	3
2.Safety rules.....	4
3.Important recommendations and cautions.....	6
4.Device construction.....	7
4.1.Indoor unit.....	7
4.2.Outdoor unit.....	7
5.Indoor unit display.....	8
6.Operating the device.....	9
6.1.AUTO-RESTART function.....	9
6.2.Emergency function.....	9
7.Remote controller.....	10
7.1.Meaning of symbols on the display.....	12
7.2.Replacement of batteries.....	13
7.3.Operation.....	13
7.4.Montage.....	14
8.Device functions.....	15
8.1."SWING" – control of the air flor.....	15
8.2.Cooling mode.....	16
8.3.Heating mode.....	16
8.4.TIMER mode – timer ON.....	17
8.5.TIMER mode – timer OFF.....	17
8.6.Fan mode.....	18
8.7.Dry mode.....	18
8.8."FEEL" – automatic mode.....	18
8.9.SLEEP MODE.....	19
8.9.1.For T1 climate conditions models.....	19
8.9.2.For tropical T3 climate condition models.....	19
9.Troubleshooting.....	20
9.1.Possible faults.....	20

1. REFRIGERANTS R32 & R290

1.1. INTRODUCTION

The refrigerants used for air conditioners are environmentally friendly hydrocarbons R32 and R290. The two kinds of refrigerants are combustible and odorless. Moreover, they can burn and explode under certain conditions. However, there will be no risk of burning and explosion if you comply with the following table to install your air conditioner in a room with an appropriate area and use it correctly.

Compared with ordinary refrigerants, Refrigerants R32 & R290 are environmentally friendly and do not destroy the ozone sphere and that their values of greenhouse effect are also very low.

1.2. ROOM AREA REQUESTS FOR AIR CONDITIONER WITH REFRIGERANTS

REFRIGERANTS	CAPACITY (Btu)	ROOM AREA
R32	10K	Above 4m ²
	13K	Above 4m ²
	20K	Above 15m ²
	22K/24K	Above 25m ²
R290	9K	Above 10m ²
	12K	Above 13m ²
	18K	Above 15m ²
	22K/24K	Above 30m ²



WARNINGS

- Please read the manual before installation, using, maintenance.
- Do not use means to accelerate the defrosting process or to clean, other than those recommended by the manufacturer.
- Do not pierce or burn the appliance.
- The appliance shall be stored in a room without continuously operating sources (for example: open flames, an operating ignition gas appliance or an operating electric heater).
- Please contact the nearest after-sale service center when maintenance is necessary. At the time of maintenance, the maintenance personnel must strictly comply with the Operation Manual provided by the corresponding manufacturer and any non-professional is prohibited to maintain the air conditioner.
- It is necessary to comply with the provisions of gas-related national laws and regulations.
- It is necessary to clear away the refrigerant in the system when maintaining or scrapping an air conditioner.























IMPORTANT INFORMATION









Before installing and commissioning the device, carefully read the operating, assembly and installation instructions.















2. SAFETY RULES

-  Read this guide before installing and using the appliance.
-  Make sure the base of the outdoor unit is firmly and securely mounted.
-  After installing the kit air conditioner, test cycle and save operational data.
-  Check that the outlet is properly grounded, change it in any case.
-  When working on terminals, all power circuits must be disconnected from the power supply.
-  Children must not have access to the assembly area when installing indoor or outdoor units.
-  The indoor unit of the air conditioner must be protected against various types of overvoltage by a safe device.
-  The ratings of the fuse installed in the built in control unit are T 5A / 250V.
-  The air conditioner must be installed by professional or qualified persons.
-  Check that the system is airtight and that there is no air or refrigerant in it.
-  Make sure that the mains voltage corresponds to the voltage on the type plate of the device. Keep the plug and cables clean. The power plug must be properly inserted into the socket, it should be firmly pressed into the socket to avoid the risk of electric shock or fire.
-  Cleaning and maintenance requires the use of qualified persons. Before proceeding, first disconnect the device from the power supply.
-  The appliance must be fitted with means for disconnection from the supply mains having a contact separation in all poles that provide full disconnection under overvoltage category III conditions, and these means must be incorporated in the fixed wiring in accordance with the wiring rules.
-  Do not install the device near flammable substances (alcohol etc.) or pressure containers (e.g. aerosol cans).
-  If the unit is to be installed in a non-ventilated area, appropriate precautions should be taken to prevent refrigerant leakage into the environment that could cause a fire.
-  The packaging materials are recyclable and should be disposed of in the separate waste bins. Take the air conditioner at the end of its useful life to a special waste collection centre for disposal.
-  Air conditioners should only be used in accordance with the operating instructions. This manual covers all possible conditions and situations that may occur.
-  Never install the air conditioner yourself, always contact specialized technical personnel.
-  The air conditioner flap, responsible for the direction of air flow (shutter), in heating devices must be armed down, and during cooling mode - up.
-  The air conditioner should always be set to the most suitable temperature for the prevailing climatic conditions.
-  The batteries in the remote control should be disposed of in a suitable container with recycling materials.



-  This appliance can be used by children aged from 8 years and above and persons with reduced physical, sensory or mental capabilities or lack of experience and knowledge if they have been given supervision or instruction concerning use of the appliance in a safe way and understand the hazards involved. Children shall not play with the appliance. Cleaning and user maintenance shall not be made by children without supervision.
-  Unplug the device and set the air louver properly if you do not intend to use it for a long time.
-  If the appliance gives off smoke or there is a smell of burning, immediately cut off the power supply and contact the service center.
-  Do not pull out the plug to switch off the appliance when it is in operation, since this could create a spark and cause a fire, etc.
-  This appliance has been made for air conditioning domestic environments and must not be used for any other purpose, such as for drying clothes, cooling food, etc.
-  All repairs are carried out only by the manufacturer's authorized service. Incorrect repairs by unqualified persons may expose you to the risk of electric shock and property damage.
-  The user is responsible for installing the unit by a qualified technician who must check that the air conditioner is grounded in accordance with applicable standards and regulations. The technician should install a thermomagnetic switch.
-  Never remain directly exposed to the flow of cold air for a long time. The direct and prolonged exposition to cold air could be dangerous for your health. Particular care should be taken in the rooms where there are children, old or sick people.
-  Always use the device with an air filter fitted. Otherwise, it can be used for excessive accumulation of dust on the connected equipment of the air conditioner, which may result in its use.

3. IMPORTANT RECOMMENDATIONS AND CAUTIONS

-  Do not use extensions or gang modules.
-  Do not leave windows or doors open for long when the air conditioner is operating.
-  Do not climb onto or place any heavy or hot objects on top of the appliance.
-  Do not bend, pull or squeeze the machine's power cord, doing so may damage it. If the electric wire is damaged, contact the service department to replace it. Otherwise, there is a risk of electric shock or fire.
-  Do not touch devices with wet or damp hands.
-  Do not obstruct the air inlet and outlet of the air conditioner and outdoor unit. Blocking them will reduce the efficiency of the devices as well as failures and damage.
-  Do not install the appliance in environments where the air could contain gas, oil or sulphur or near sources of heat.
-  The device may not be used by children under 8 years of age, mentally or physically handicapped persons and persons without the use of experience and knowledge.
-  Long and direct exposure of the cold air stream to plants and animals can have a negative effect.
-  Do not install the device in wet and humid places (e.g. bathroom). Electrical insulation can be damaged and cause an electric shock.
-  Do not aim the air conditioner at the plants and animals.
-  Do not insert any things into the device, it may cause body injury.

4. DEVICE CONSTRUCTION

4.1. INDOOR UNIT

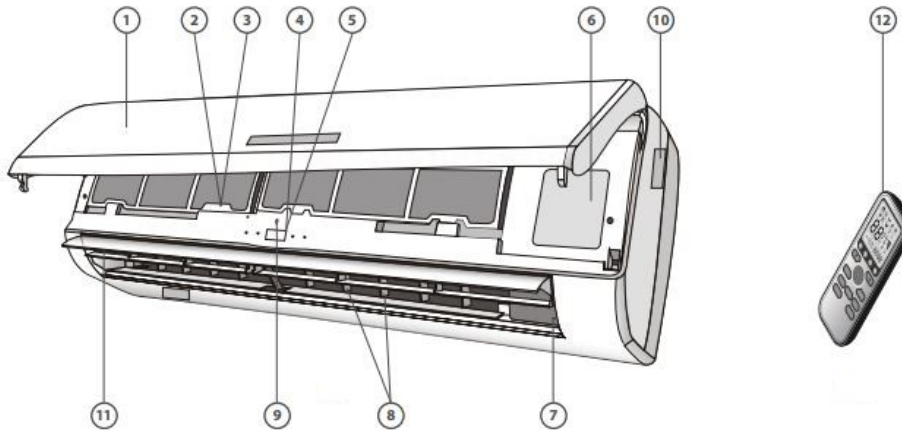

- | | |
|-----------------------------------|-------------------------------------|
| 1. Front panel | 7. Ionizer generator (if installed) |
| 2. Air filter | 8. Deflectors |
| 3. Optional filter (if installed) | 9. Emergency button |
| 4. LED display | 10. Nominal label |
| 5. Signal receiver | 11. Airflow direction louver |
| 6. Terminal block cover | 12. Remote controller |

4.2. OUTDOOR UNIT

1. Air outlet grille
2. Nominal label
3. Terminal block cover
4. Gas valve
5. Liquid valve

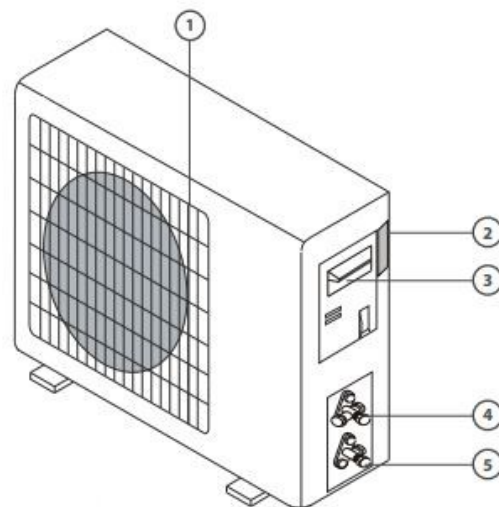

 *Note: the above drawings are illustrative drawings.*

5. INDOOR UNIT DISPLAY

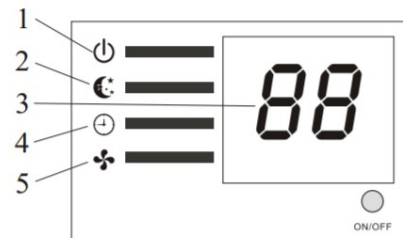
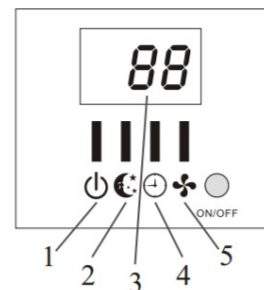
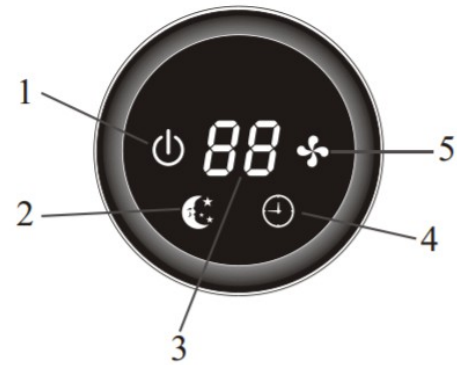
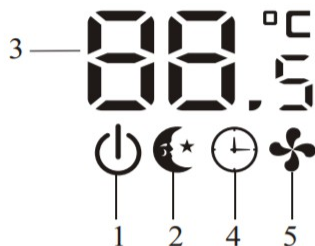
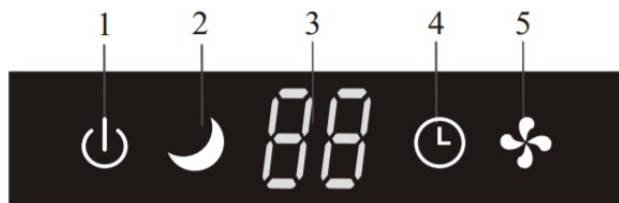
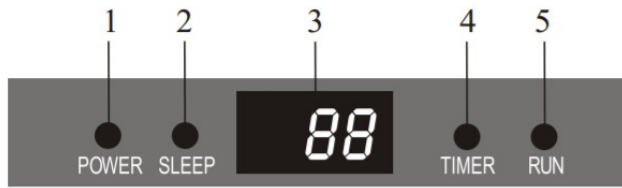

Lp.	LED		FUNCTION
1	POWER		This symbol appears when the unit is power on
2	SLEEP		SLEEP mode
3	TEMP. DISPLAY / ERROR		(1) Lights up during Timer operation when the air conditioner is operational. (2) Displays the malfunction code when fault occurs.
4	TIMER		Lights up during Timer operation.
5	RUN		The symbol appears when the unit is turned on, and disappear when the unit is turned off.

The shape and position of switches and indicators may be different according to the model, but their function is the same.

6. OPERATING THE DEVICE

6.1. AUTO-RESTART FUNCTION

The appliance is present auto-restart function by manufacturer. In case of a sudden power failure, the module memorizes the setting conditions before the power failure. When the power restores, the unit restarts automatically with all previous settings preserved by the memory function.

• **To deactivate the AUTO-RESTART function, proceed as follows.**

1. Switch the air conditioner off and plug it off.
2. Press the emergency button meanwhile plug it in.
3. Keep pressing the emergency button for more than 10 seconds until you hear four short beeps from the unit. The AUTO-RESTART function is deactivate.

• **To activate the AUTO-RESTART function, follow the same procedure until you hear three short beeps from the unit.**

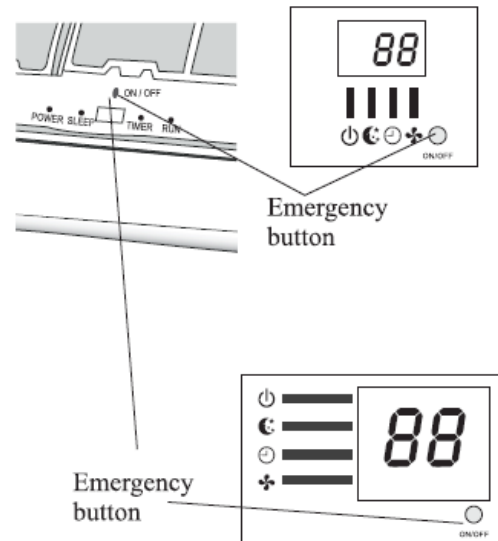

6.2. EMERGENCY FUNCTION

If the remote controller fails to work or maintenance necessary, proceed as follows. Open and lift the front panel up to an angle to reach the emergency button.

1. One press of the emergency button (one beep) will lead to the forced cooling operation.
2. Two press of the emergency button within 3 sec (two beeps) will lead to the forced heating operation.
3. To switch off the unit, you just need to press the button again (a single long beep).
4. After 30 minutes in forced operation, the air conditioner will automatically start working in 23°C cooling mode, aut fan speed.

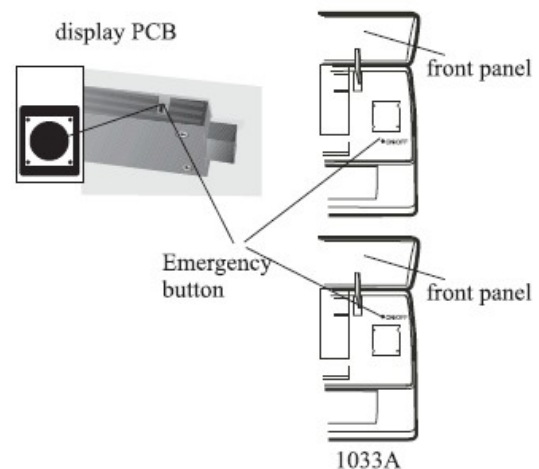

The shape and position of the emergency button may be different according to the model, but their function is the same.



The external static pressure of heat pumps is 0 Pa for all models.

7. REMOTE CONTROLLER

Lp.	BUTTON	FUNCTION
1	▲ (TEMP UP)	Press it to increase temperature / time setting
2	▼ (TEMP DOWN)	Press it to decrease temperature/ time setting
3	ON/OFF	Press it to start or stop operation
4	FAN	To select the fan speed of auto/low/mid/high
5	TIMER	Press it to set auto-off timer
6	SLEEP	To activate the function SLEEP
7	ECO	Use this button to enable / disable the ECO function
8	MODE	To select the mode of operation
9	SUPER or TURBO	Press this button to activate / deactivate the Super function which enables the unit to reach the preset temperature in the shortest time. In COOL mode, the unit will give the maximum cooling temperature with 16°C ,high fan speed. In HEAT mode, the unit will give the maximum heating temperature with 31°C ,high fan speed
10	SWING	To activate or deactivate of the movement of the deflectors.
11	CLOCK	When you press this button, the time will be flickering; then through ▲ and ▼ ,you can adjust the time (one time you press, one minute you adjust; and if you continue to press, the time change rapidly), after adjusting to your required time, please press this button again to fix the time
12	DISPLAY	To switch on/off the LED display
13	HEALTHY	To switch - on /off HEALTHY function. It is a button which controls the ionizer or plasma generator for available model only
14	3D	When you press "3D", the horizontal and vertical vanes will swing together at the same time
15	RESET	To restart REMOTE CONTROLLER
16	ANTI-MILDEW or MUTE	To activate the function ANTI-MILDEW or to activate the function of mute

 The out looking and some function of remote controller maybe difference.

 The shape and position of buttons and indicators maybe difference according to the model, but their function is the same.



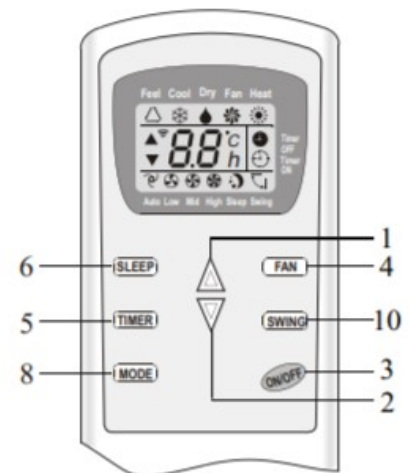
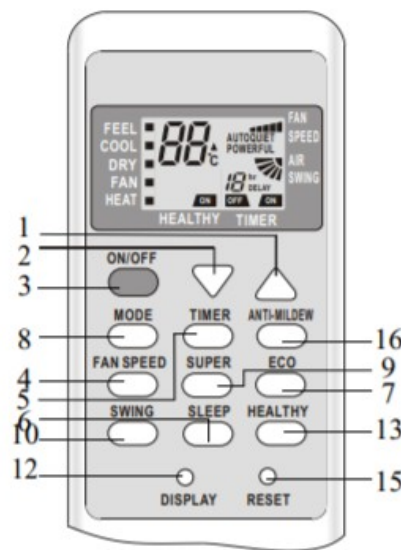
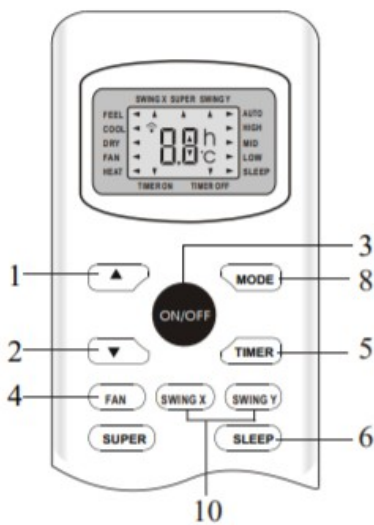
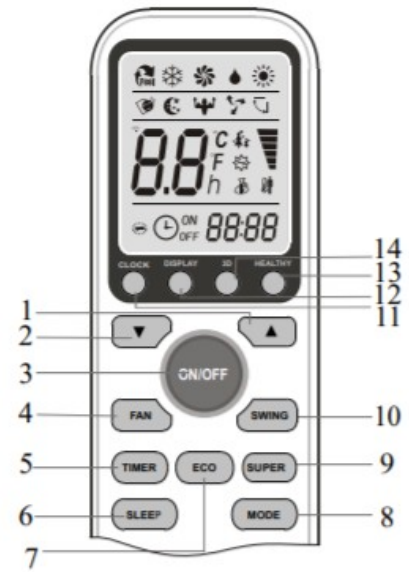
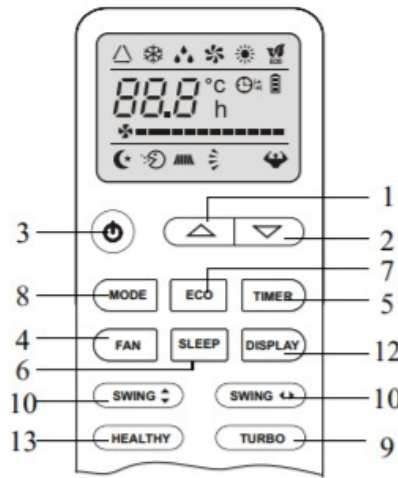
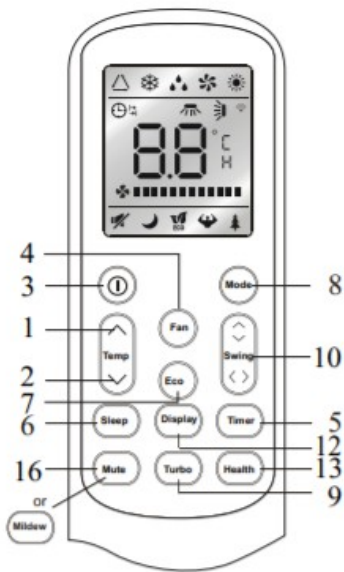













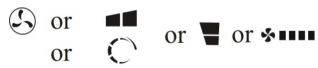

 The unit confirms the correct reception of each press button with a beep.

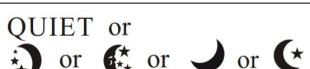

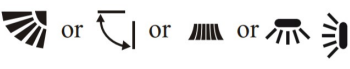

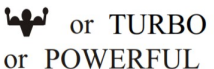

⚠ The out looking and some function of remote controller maybe difference.

⚠ The shape and position of buttons and indicators maybe difference according to the model, but their function is the same.



7.1. MEANING OF SYMBOLS ON THE DISPLAY

Lp.	BUTTON	FUNCTION
1		FEEL mode indicator
2		COOLING indicator
3		DEHUMIDIFYING indicator
4		FAN ONLY OPERATION indicator
5		HEATING indicator
6		SIGNAL RECEPTION indicator
7		TIMER OFF indicator
8		TIMER ON indicator
9		AUTO FAN indicator
10		LOW FAN SPEED indicator
11		MIDDLE FAN SPEED indicator
12		HIGH FAN SPEED indicator
13		SLEEP indicator
14		COMFORTABLE SLEEP indicator (optional)
15		FEEL indicator (optional)
16		FLAP SWING indicator
17		FLAP and deflectors SWING indicator
18		SUPER indicator
19		HEALTHY indicator
20		ECO indicator
21		ANTI-MILDEW indicator

22	 or 	BATTERY indicator
23		CLOCK indicator
24		MUTE indicator

7.2. REPLACEMENT OF BATTERIES

Remove the battery cover plate from the rear of the remote controller, by sliding it in the direction of the arrow. Install the batteries according the direction (+ and -) shown on the remote controller.

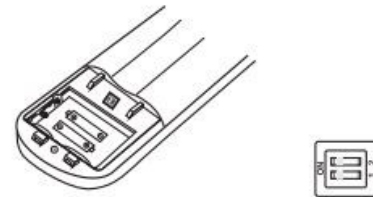
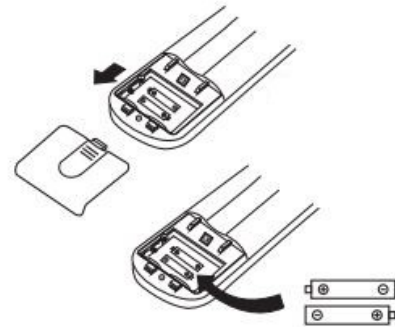

-  Use 3 AAA (1.5V) batteries. Do not use rechargeable batteries. Replace the old batteries with new ones of the same type when the display is no longer legible.
-  When you open the battery cover, you can see DIP switch on the cover back.







DIP SWITCH ON POSITION	FUNCTION
°C	Adjusted in degree Celsius
°F	Adjusted in degree Fahrenheit
Cool (COOL)	Adjusted in only cooling mode
Heat (HEAT)	Adjusted in cooling and heating mode

7.3. OPERATION

When you insert the batteries for the first time in the remote controller or if you change them, you need to program the remote controller of only cooling or cooling and heating.

-  When you insert the batteries the symbols (COOL) i (HEAT) start flashing. If you push whatever button when the symbol (COOL) is displayed, the remote controller is adjusted in only cooling mode.
-  If you push whatever button when the symbol (HEAT) is displayed, the remote controller is adjusted in cooling and heating mode.

 *If you adjust the remote controller in cooling mode, it will not be possible to activate the heating function in units with heating pump. You need to take out the batteries and repeat the procedure described above.*

-  Direct the remote controller toward the Air conditioner
-  Check that there are no objects between the remote control and the signal receptor in the indoor unit.
-  Never leave the remote controller exposed to the rays of the sun.
-  Keep the remote controller at a distance of at least 1m from the television or other electrical appliances.

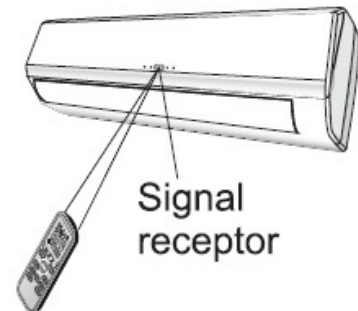

7.4. MONTAGE

Recommendations for locating and using the remote controller holder (if present). The remote controller be kept in a wall-mounted holder.



8. DEVICE FUNCTIONS

The air sucked by the fan enters from the grill and passes through the filter, then it is cooled/dehumidified or heated through the heat exchanger.

The direction of the air outlet is motorized up and down by flaps, and manually moved right and left by the vertical deflectors, for some models, the vertical deflectors could be controlled by motor as well.

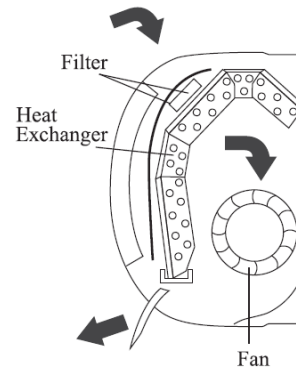

8.1. "SWING" – CONTROL OF THE AIR FLOW

It is possible to set the air direction optimally.

The key (SWING) activates the FLAP, the air flow is directed alternatively from up to down. In order to guarantee an even diffusion of the air in the room.

The key (SWING) activates the motorized deflectors the air flow is directed alternatively from left to right.

- In cooling mode, orient the flaps in horizontal direction.
- In heating mode, orient the flaps downward as the warm air tends to rise.

The deflectors are positioned manually and placed under the flaps. They allow to direct the air flow rightward or leftward.

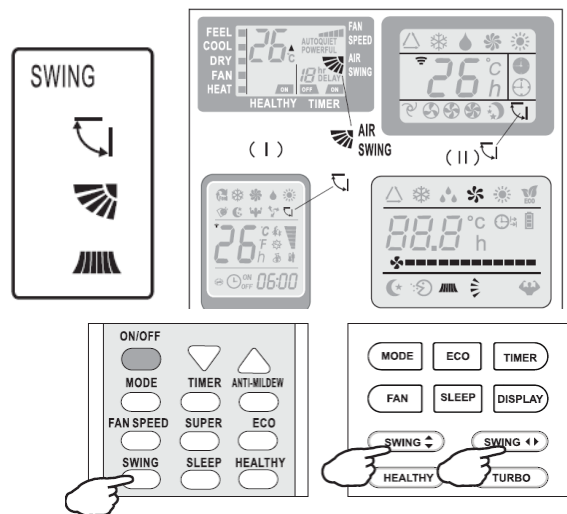

Never position FLAPS manually, the delicate mechanism might seriously damaged!

Never poke fingers, sticks or other objects in the air inlet or outlet vents. Such accidental contact with live parts might cause unforeseeable damage or hurt.

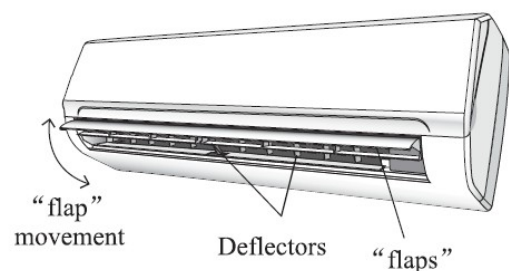

8.2. COOLING MODE

The cooling function allows the air conditioner to cool the room and at the same time reduces air humidity.

To activate the cooling function (COOL), press the (MODE) button until the symbol ❄️ (COOL) appears on the display.

The cooling function is activated by setting the button ▲ or ▼ at a temperature lower than that of the room.

To optimize the function of the air conditioner, adjust the temperature, the speed and direction of the air flow by pressing the button indicated.

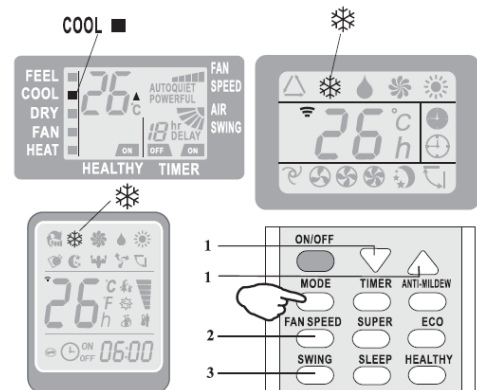

8.3. HEATING MODE

The heating function allows the air conditioner to heat the room.

To activate the heating function (HEAT), press the (MODE) button until the symbol ☀️ (HEAT) appears on the display.

With the button ▲ or ▼ set a temperature higher than that of the room.

To optimize the function of the air conditioner adjust the temperature, the speed and the direction of the air flow by pressing the button indicated.

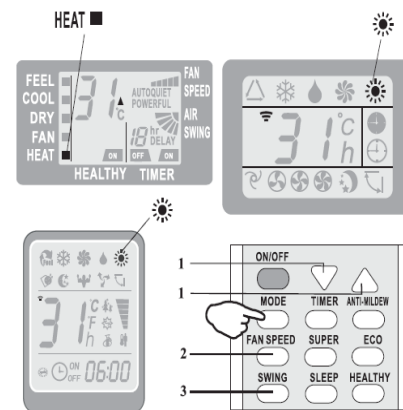

⚠️ In HEATING operation, the appliance can automatically activate a defrost cycle, which is essential to clean the frost on the condenser so as to recover its heat exchange function. This procedure usually lasts for 2-10 minutes during defrosting, in for unit fan stop operation. After defrosting, it resumes to HEATING mode automatically.

8.4. TIMER MODE – TIMER ON

To program the automatic switching-on time, the appliance should be power off.

- Press (TIMER) at the first time, set the temperature with pressing the button ▲ or ▼ .
- Press (TIMER) at the second time, set the rest time with pressing the button ▲ or ▼ .

Press (TIMER) at the third time, confirm the setting, then the rest time to next automatic switching-on could be read on the display

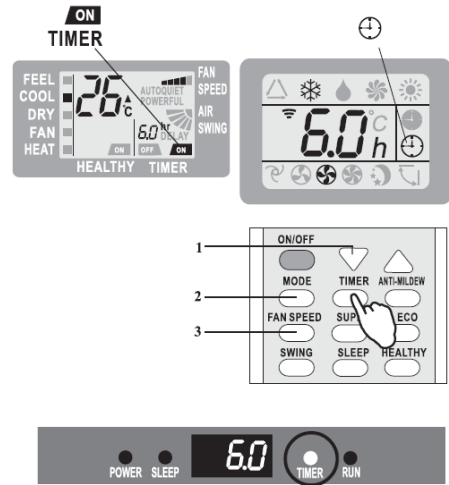

NOTE

Before proceeding with the time: program the working mode with the button (MODE) and the fan speed with the button (FAN). Switch the conditioner off (with the key ON/OFF).

- To cancel the setted function, press the (TIMER) button again.
- In case of power off, it is necessary to set (TIMER) ON again.

8.5. TIMER MODE – TIMER OFF

- The timed stop is programmed by pressing (TIMER), set the rest time by pressing the button ▲ or ▼ , until the rest time displayed is to your demand the press (TIMER) again.

NOTE

- To cancel the setted function, press the (TIMER) button again.
- In case of power off, it is necessary to set TIMER OFF again.
- The TIMER function can be set at half-hour intervals.

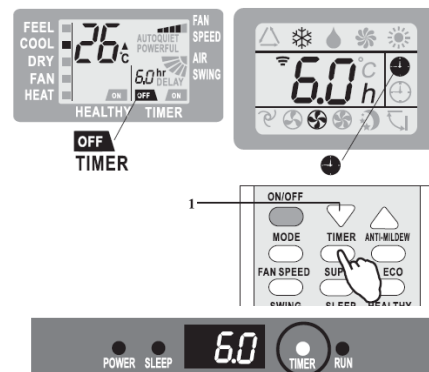



8.6. FAN MODE

To set the FAN mode, press (MODE) until (FAN) appears in the display.

When pressing (FAN) button the speed changes in the following sequence: LOW/ MEDIUM/ HIGH/ AUTO in FAN mode.

The remote control also stores the speed that was set in the previous mode of operation.

In FEEL mode (automatic) the air conditioner automatically chooses the fan speed and the mode of operation (COOLING or HEATING).

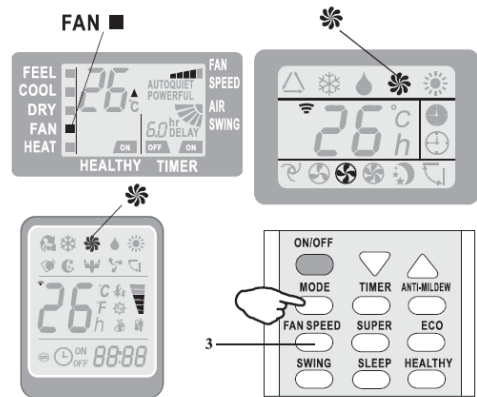

8.7. DRY MODE

This function reduces the humidity of the air to make the room more comfortable.

To set the DRY mode, press (MODE) until (DRY) appears in the display. An automatic function of alternating cooling cycles and air fan is activated.

The function of alternating operation of the air conditioner in the COOLING and FAN functions will be activated.

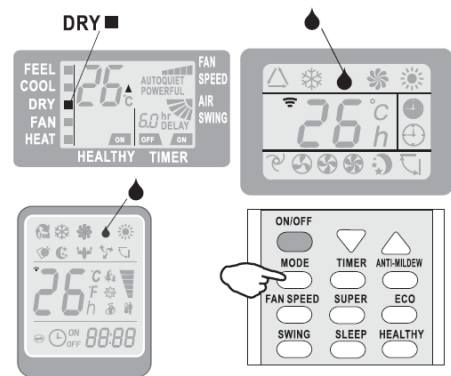

8.8. "FEEL" – AUTOMATIC MODE

To activate the FEEL (automatic) mode of operation, press the (MODE) button on the remote controller until the symbol (FEEL) appears on the display.

In FEEL mode the fan speed and the temperature are set automatically according to the room temperature (tested by the temperature sensor which is incorporated in the indoor unit).

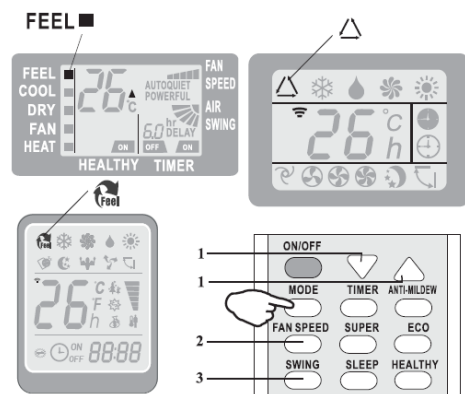

Ambient temp.	Operation mode	Auto temp.
< 20 °C	HEATING(for heat pump type) FAN (for cool only type)	23°C
20°C ~ 26°C	DRY	18°C
> 20°C	COOL	23°C

8.9. SLEEP MODE

To activate the SLEEP mode of operation, press the (SLEEP) button on the remote controller until the symbol (AUTOQUIET) appears on the display. The function SLEEP automatically adjusts the temperature to make the room more comfortable during the night. In cooling or dry mode, the set temperature will automatically raise by 1°C every 60 minutes, to achieve a total rise of 2°C during the first 2 hours of operation.

In heating mode the set temperature is gradually decreased by 2°C during the first 2 hours of operation.

After 10 hours running in sleep mode the air conditioner is switched off automatically.

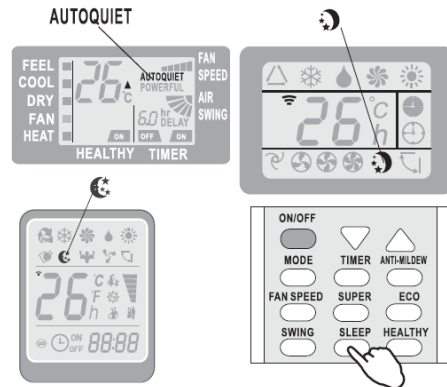

The air conditioner is programmed for comfortable and suitable living conditions, if it is used in abnormal conditions as below, certain safety protection features might come into effect.

8.9.1. FOR T1 CLIMATE CONDITIONS MODELS

Lp.	MODE	AMBIENT TEMP.
1	Heating	Outdoor temperature is over 24°C
		Outdoor temperature is below -7°C
		Room temperature is over 27°C
2	Cooling	Outdoor temperature is over 43°C
		Room temperature is below 21°C
3	Dry	Room temperature is below 18°C

8.9.2. FOR TROPICAL T3 CLIMATE CONDITION MODELS

Lp.	MODE	AMBIENT TEMP.
1	Heating	Outdoor temperature is over 24°C
		Outdoor temperature is below -7°C
		Room temperature is over 27°C
2	Cooling	Outdoor temperature is over 52°C
		Room temperature is below 21°C
3	Dry	Room temperature is below 18°C



The unit does not operate immediately if it is turned on after being turned off or after changing the mode during operation. This is a normal self-protection action, you need wait for about 3 minutes.



9. TROUBLESHOOTING

9.1. POSSIBLE FAULTS

Case	Possible cause
Device doesn't work	A power failure / defective plug has occurred
	Indoor / outdoor unit fan motor damaged
	Compressor thermomagnetic switch defective
	Defective protective device or fuses
	Too loose connections or plug
	Automatic off device, self-protection function
	Higher or higher voltage than recommended
	TIMER ON function active
	Motherboard damage
Strange smell	The air filter is dirty
Sound of flowing water	Regression liquid in the drain
A slight mist is emitted from the air outlet	This happens when the air in time becomes very cold, for example in COOL or DRY modes
Strange noise	This noise is caused by expansion or contraction of the front panel due to temperature changes, not a problem
Insufficient air flow, too hot or cold	Incorrect temperature setting
	The air inlet or outlet of the indoor or outdoor unit is blocked
	The air filter is blocked
	The fan speed is set to the minimum
	Other heat sources in the room
	No refrigerant
The device does not respond to commands	The remote control is not close enough to the indoor unit
	Low battery on the remote control
	There is an obstacle between the remote control and the signal receiver on the main unit
Display is off	LED function active
	No power